

2600M

POWERKEY ULTIMATE

STANDARD FEATURES

- Supply voltage 12-24v
- Relegendable buttons
- Multicolour indicator rings
- Vertical or horizontal mount
- Improved thermal dissipation
- Full colour LED indicators - including pure white
- Standard and custom legends
- Added overload feedback on output drives to detect short circuit or over current events
- Significant power reductions - PKU mini consumes with all LED's active 107mA@12v
- Simplified CAN messaging using our CANconnect software to control multiple LED's within a single message
- Brighter LED's
- LED backlit icons
- Sealed IP68
- CRM or Designer

IMPROVED DESIGNER FIRMWARE FEATURES

- 256 step brightness control for each colour
- New LED visual effects (blink, pulse, spin ripple)
- On / Off, momentary, toggle, scroll/step functions programmable for each key
- Autonomous operation (key press causes LED to change state without feedback from external device)
- NMEA2000 bus compliant (support ISO requests, address claim, binary status 127501 and binary control 127502 messages)

PROTOCOLS & ACCESSORIES

- Optional Bezels
- CANopen
- J1939
- NMEA 2000
- Connector options include:
 - Deutsch, Molex and more
 - Accessories Catalogue
- Optional Finger guards
- Free Software Utility



FLEXIBLE - SMART - RUGGED

SPECIFICATIONS

ELECTRICAL

Supply Voltage	12/24 VDC Nominal (8-32VDC)
Standby Current	<50 mA
Communication BUS	CANopen, J1939

MECHANICAL

Connector	Deutsch DT04-4P, Molex 19418-0004, Micro-C and more
Switch Life	3 Million operations
Mechanical Shock	X, Y, Z 50Gs 11ms
Vibration	X, Y, Z 10 - 150Hz 0.15mm amp
Mounting Studs	#10-32 CDS-510 phosphor bronze, electroplated bright tin
Keypad	Silicone rubber with polyurethane hardcoat
Operating Temperature	-40 °C to +85 °C
Storage Temperature	-40 °C to +85 °C
Thermal Shock	-40 ° to +72 °C @4 °C/Min
Humidity	0 to 98% (no condensation)
UV Protection / Salt Spray	UVB 400 hours / Per ASTM B117
Chemical Resistance	DEET, Engine Cleaner, Isopropyl Alcohol, Suntan Lotion, Multi-Purpose Cleaner, Orange Citrus Cleaner
Ingress Protection	IP68/NEMA6

DIMENSIONS

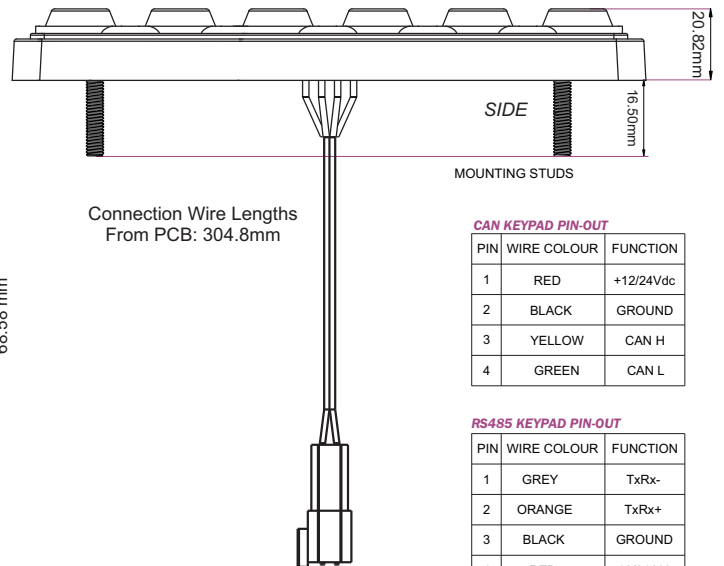
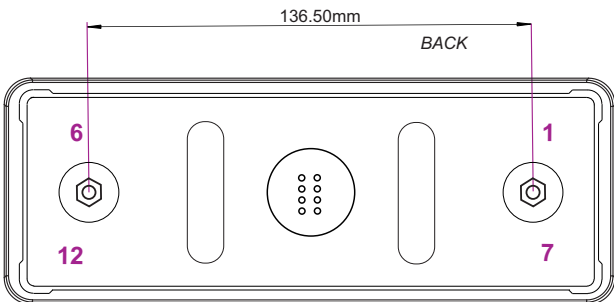
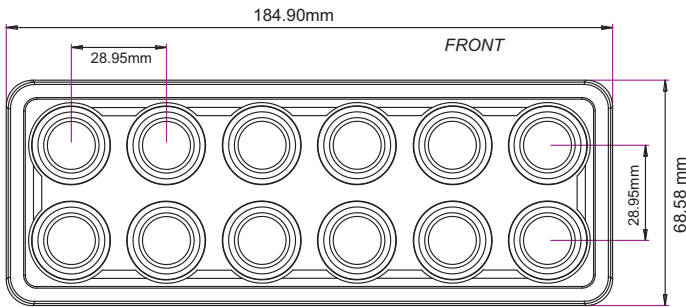

CAN KEYPAD PIN-OUT

PIN	WIRE COLOUR	FUNCTION
1	RED	+12/24Vdc
2	BLACK	GROUND
3	YELLOW	CAN H
4	GREEN	CAN L

RS485 KEYPAD PIN-OUT

PIN	WIRE COLOUR	FUNCTION
1	GREY	TxRx-
2	ORANGE	TxRx+
3	BLACK	GROUND
4	RED	+12/24 Vdc

* Diagrams are NOT to Scale

MOUNT ON A FLAT SURFACE ONLY

Part Number:	GEC-PKU2600M
Nut Size*:	10-32 UNF S/S
Washer Sizes:	M5 Spring Washer S/S, M5 Flat Washer S/S
Torque Maximum:	7 +/- 1 in. lbs

* DO NOT USE NYLOC NUTS